

HIGHLY
SECURE
VANDAL RESISTANT

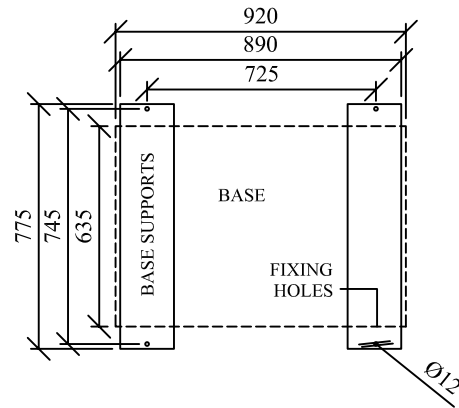

PLAN VIEW
OF UNIT BASE

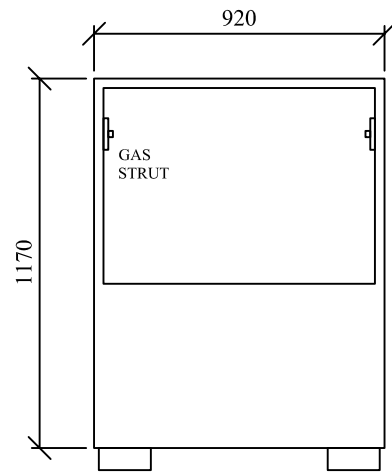

VIEW OF ACCESS
OPENING - LID
REMOVED

BASE SUPPORTS DOUBLE
AS FORKLIFT POINTS

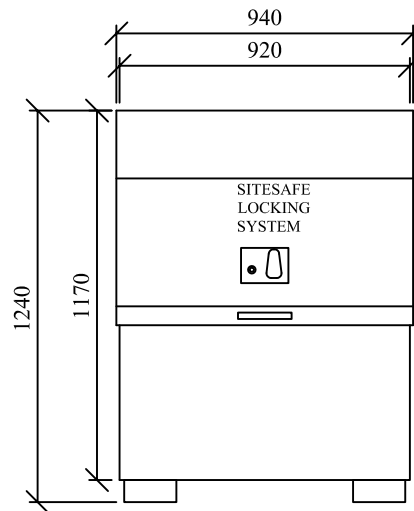

FRONT ELEVATION

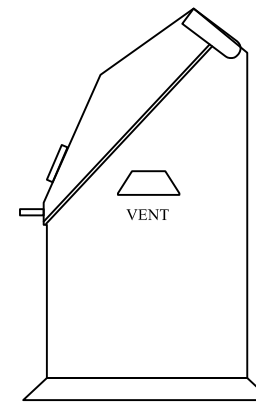

SIDE ELEVATION

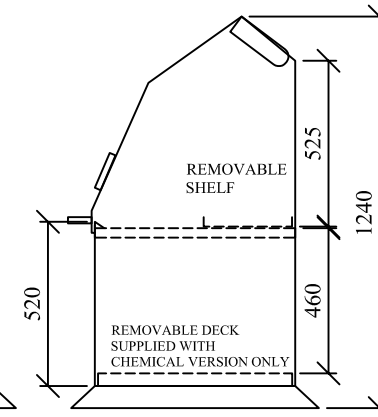

SIDE ON SECTION

DO NOT SCALE

REMOVE ALL
BURRS AND
SHARP EDGES



REV No	DATE	BY
REV 1		
REV 2		
REV 3		
REV 4		

CUSTOMER

CLEVELAND
SITESAFE
LIMITED

RIVERSIDE WORKS
CLEVELAND
TS3 RAT
01642 244663

DRAWN
JWH
SCALE

DATE
26/06/2009

DESCRIPTION

UNIVERSAL 270 UNIT

DRG No UNI270WEB