

HIGHLY
SECURE
VANDAL RESISTANT

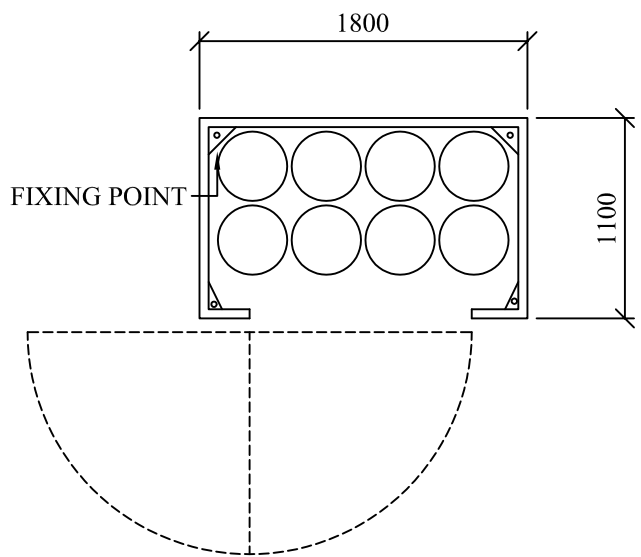

PLAN

ZINC PHOSPHATE
PAINT FINISH

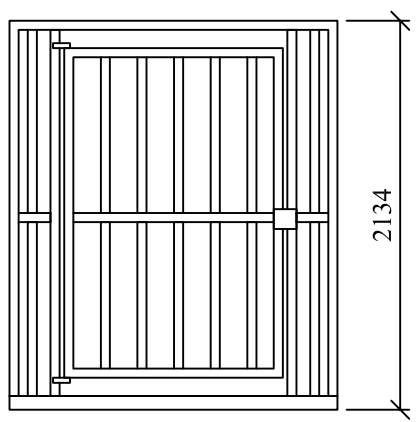

FRONT ELEVATION

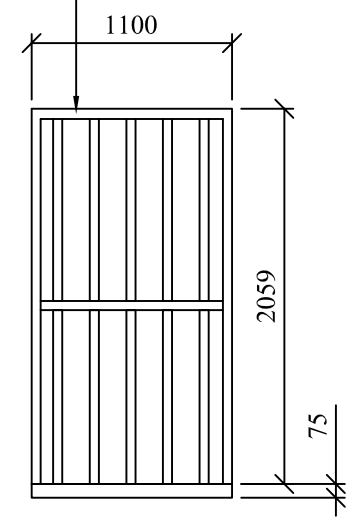

SIDE ELEVATION

DO NOT SCALE REMOVE ALL BURRS AND SHARP EDGES	 THIRD ANGLE PROJECTION	REV No	DATE	BY	CUSTOMER	CLEVELAND SITESAFE LIMITED <small>RIVERSIDE WORKS CLEVELAND TS3 RAT 01642 244663</small>	DRAWN	DESCRIPTION GAS BOTTLE CAGE FOR APPROX 8 BOTTLES DRG No GASB8WEB2012
		REV 1					JWH	
		REV 2					SCALE	
		REV 3					DATE	
		REV 4					10/12/2012	